



9 Specifications

Operating Data	RVM/U-1		RVM/U-2		RVM/U-4	
Pressure: brass	PN 250 bar		PN 300 bar		PN 300 bar	
Pressure: stainl. steel	PN 300 bar		PN 350 bar		PN 350 bar	
Pressure drop.:	0,02 - 0,4 bar		0,02 - 0,3 bar		0,02 - 0,2 bar	
Temperature max.:	100°C (optional 160°C)					
Accuracy:	±10% of final value					
Electrical Data:	SPST N.O.	SPDT	SPST N.O.	SPDT	SPST N.O.	SPDT
IP65 (plug connection DIN43650 Form A or C)	max. 250V • 3A • 100 VA	max. 250V • 1,5A • 50VA ⁽¹⁾	max. 230V • 1A • 60VA	max. 250V • 1,5A • 50VA ⁽¹⁾	max. 200V • 1A • 20VA	max. 200V • 1A • 20VA
IP67 (with 1m sealed in cable)						
M 12x1 plug Temperature max. 85°C	not available		max. 125V • 3A • 60VA	max. 125V • 1,5A • 50VA	max. 125V • 1A • 20VA	max. 125V • 1A • 20VA
⊕ Atex II 2G EEx m II T6 max. 80°C (2m sealed in cable IP67)	max. 250V • 2A • 60VA	max. 250V • 1A • 30VA	max. 250V • 2A • 60VA	max. 250V • 1A • 30VA	not available	
EEx m II T6 max. 80°C	max. 250V • 2A • 60VA	max. 250V • 1A • 30VA	max. 250V • 2A • 60VA	max. 250V • 1A • 30VA	not available	
Output signal:	The contact switches off, if minimum flow is below setpoint					
Power supply:	not necessary (reed contacts)					
Cable diameter for IP65:	6 - 8 mm		4 - 6,5 mm			
Grade of pollution:	2 (EN 61058-1)					

Other plug types or cable lengths on request

Materials	brass	stainl. st.
Wetted parts:	brass	1.4571 (316 ti)
Spring (wetted parts)		1.4571 (316 ti)
Magnets (wetted parts)		hard-ferrite
Seals (with reducers only)	NBR (other on request)	Viton (other on request))

(1) Minimum load 3VA

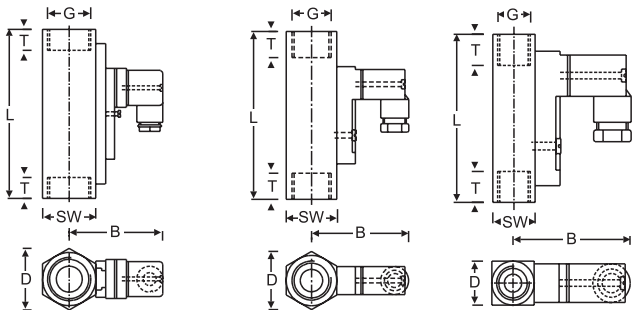

	SW	D	B	G	DN	T	L
RVM/U-4	17	17	47	1/4"	8	10	65
RVM/U-2	27	31	52	1/2"	15	14	90
RVM/U-1	41	47	76	3/4" 1"	20 25	21 17	152 130

Overall dimensions mm

Y SCOF ca à'À a* à àU OBAI ESÖ
 CP ca à'À EY a* à àU ca ^A E
 OOË HUFFA Sja* ^*) à'À' E' E' à



Content

1 Preface	1
2 Safety hints	1
3 Principle of operation	1
4 Installation	1
5 Electrical connection	2
6 Switch point adjustment	3
7 Maintenance	3
8 Fault finding hints	3
9 Specifications	4

1 Preface

The flowmonitors type RVM/U prove themselves through reliability and simple handling. To use the advantages of the instrument to the full extent, please take notice of the following:

Every person, in charge of commissioning and operating this instrument, must have read and understand this operating instruction and specially the safety hints!

2 Safety hints

1 General hints

The instructions contained in the operating instructions must be followed to ensure a safe operation of the instrument. Further, the additional Legal- and safety-regulations for the individual application must be observed. Accordingly this applies for the use of accessories as well.

2.2 Application as directed

The instruments, type RVM/U, serve as monitors for continuous flow of liquids. Any other use counts as nondirected. If not indicated otherwise, the scaling of the instruments refer to water. Special applications, where intermittent loads (e.a. cyclic operation) could occur, should be discussed and checked with our technical Staff.

The instruments, type RVM/U, must not be used as single source to avoid dangerous situations on machinery and in plants. Machinery and plants must be constructed in that way, that faulty conditions do not lead the operators into dangerous situations.

2.3 Qualified personnel

The instruments, type RVM/U, must only be installed by qualified personnel, which is capable of using these instruments in a professional manner. Qualified personnel are such persons, which are familiar with the erection, installation, commissioning and operation of these instruments and which hold a corresponding qualification for this function.

B RVM_U 0008 10-09 E M

3 Principle of operation

The instruments type RVM/U operate on the principle of the float type flow indicator. Through the flowing medium a float is set in motion, whose integrated magnets create a magnetic field. The position of the float is detected with the switch contact. The float is reset to the starting point by means of a spring, which allows the installation in any position in a system. The instruments are adjusted for the installation with flow from bottom to top. The weight of the float influences the measuring result, therefore a different mounting position will show discrepancies to the actual flow

4 Installation

4.1 Process connection

Caution! To avoid the damage of the flowmonitor or the installation the following requirements must be fulfilled under any circumstances:

- suitable process connection has to be provided
- connection size to be checked
- thread depth to be checked
- suitable sealing material to be used (liquid sealing material will damage the flowmonitor if it gets inside)
- professional sealing

4.2 Environment conditions

- The flowmonitor must not be used as a supporting part in a pipe construction.
- The medium must not contain any solid particles. Magnetic particles will accumulate at the magnetic float and effect the function.
- Before employment of anti-freeze and anti-corrosive check compatibility.

Warning! The following requirements must be adhered to, otherwise the function of the flowmonitor will be affected or the measuring results will be falsified:

- External magnetic fields will influence the switch contact. Keep sufficient distance to magnetic fields (e.a. Electricmotors).
- Piping, process connections or supports made from ferromagnetic material influence the magnetic field of the flowmonitor. Keep a space of 100mm to those materials (e.a. steel).
- The accuracy is influenced by cross-section changes, branches or elbows in the piping. Provide a straightening section of 10x DN upstream and 5x DN downstream of the instrument. Never reduce the pipe diameter direct ahead of the instrument!
- With liquids ensure through suitable steps the de-aeration of the instrument.

5 Electrical connection

The switch contacts are potential free and do not need any supply.

Attention! Switch contact and unit are matched. After the exchange of a switch contact a readjustment must be made. Kindly request the relevant instruction.

Switch position under No flow condition:

Connection: normally open

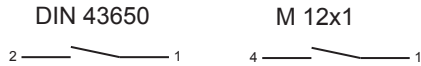

Connection: change over

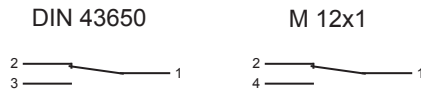

5.1 Standard switch contact

Pin-allocation of the supplied socket (DIN 43650 Form A or C). The Ground-pin is not used.

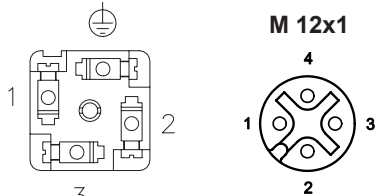

Important instruction:
When using the socket DIN 43650, the ingress protection IP65 is only warranted in connection with a suitable cable diameter.
For infos on this subject please refer to page 4.

5.2 Switch contact with cable

The individual cores of the cable are marked according to the above connection diagram.

5.3 Special design

On request special designed switch contacts (socket, ready-made cable) can be supplied.

5.4 EEx-proof switch contacts

Attention!
For the connection of EEx-proof switch units special instructions apply, which must be followed! Pay attention to the hints in the separate operating instruction for EEx-proof switch contacts!

5.5 Contact protection arrangement

Attention!
The following requirements must be adhered to under any circumstances, otherwise the switch contact will be destroyed!

The reed-contacts employed in the switch contacts are, due to their construction, very fragile against overload. None of the values voltage, current and wattage must be exceeded (Not even for a fractional moment).

The danger of overloads exist by means of:

- inductive loads
- capacitive loads
- resistive loads

Inductive load

This kind of load will be caused by:

- contactors, relays
- solenoid valves
- electricmotors

Danger:

Voltage peaks during switch off (up to 10-times of the nominal voltage)

Precautionary measure: (sample)

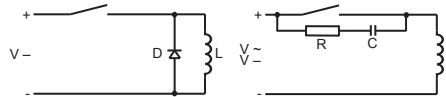

Capacitive load

This kind of load will be caused by:

- extrem long leads
- capacitive consumption

Danger:

High current peaks during switch on of the switch contact (exceeding the nominal current)

Precautionary measure: (sample)

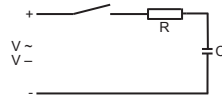

Limiting the current by means of a resistor

Resistive load

This kind of load will be caused by:

- incandescent bulbs
- Motor start up

Danger:

High current peaks during switch on of the switch contact, because the filament has low resistance at low temperatures.

Precautionary measure: (sample)

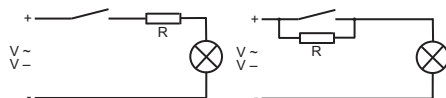

Limiting the current by means of a resistor or heating of the filament

Connection to SPS

For the connection to high resistance devices (like SPS) a protection circuit is not necessary.

6 Switchpoint adjustment

- Loosen the lock screw of the switch contact
- Shift the switch contact until the arrow on the switch contact is in coincidence with the desired switch point.
- Tighten the lock screw of the switch contact.

Hints:

- The adjusted switch point corresponds to the switch off point of the switch contact with decreasing flow.
- The actual switch position can be checked by means of an universal tester.
- The above description of the adjustment refers to the normally open contact.

7 Maintenance

Due to the few moving parts the instruments do not require much service.

A functional check and service on a regular base will not only increase the lifetime and reliability of the instrument, but of the entire plant.

The service intervals depend on

- the pollution of the media
- environmental conditions (e.a. vibrations)

During maintenance at least the following points should be checked:

- operation of the switch contact
- leakage test of the instrument
- free movement of the float

It is the obligation of the user to lay down appropriate service intervals depending on the application.

Hints:

- The free movement of the float and the operation of the switch contact can be checked by varying the flow and observing the switch contact status.
- In most cases a purification can be achieved by flushing the instrument with clean media. In obstinate cases (e.a. calcareous deposits) cleaning can be done with commercial purifier, as long as the purifier is not aggressive against the material of the instrument.

8 Fault finding hints

The switch contact does not react:

- The switch contact is permanent in break position

- 1. No flow**
 - ▶ check for medium flow
- 2. Flow to low or switch contact adjusted to high**
 - ▶ Adjust switch point to a lower flow
 - ▶ Use instrument with different range
- 3. Incorrect reduced (pipe diameter to small)**
 - ▶ reduce according to section 4
- 4. Float got stuck (polluted)**
 - ▶ Clean the instrument and ensure free movement of the float
- 5. Switch contact faulty**
 - ▶ Eliminate the reason for the fault (short circuit, overload)
 - ▶ Exchange switch contact, refer section 5

- The switch contact is permanent in made position

- 1. Flow to high and switch contact adjusted to low**
 - ▶ Reduce flow
 - ▶ Adjust switch contact to a higher flow
- 2. Float got stuck (polluted)**
 - ▶ Clean the instrument and ensure free movement of the float
- 3. Switch contact faulty**
 - ▶ Eliminate the reason for the fault (short circuit, overload)
 - ▶ Exchange switch contact, refer section 5

- Switch point does not match with actual flow

- 1. No medium specific scale**
 - ▶ Request a correction table or medium specific scale
- 2. Incorrect reduced**
 - ▶ reduce according to section 4
- 3. Instrument polluted**
 - ▶ clean the instrument
- 4. Instrument defect**
 - ▶ Return instrument for repair and calibration to manufacturer